

# FlexiBowl<sup>®</sup>

by **ars**

---

## *Backlight and Toplight Datasheet*

---

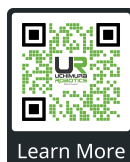

## Backlight FlexiBowl® 200



Item	CE000351	CE000278	CE000331
Led Colour	Red	Infrared	White
Wavelength	630nm	850nm	N/A
Voltage	24VDC	24VDC	24VDC
Current	0.17A	0,12A	0,17A
Lighting area	155X75mm <sup>2</sup>		
Housing material	Aluminium alloy		
Working Temperature	-40--85°C		
Cable length	0.2m		
Cooling method	Natural air		
Opaline Material	Opaline white methacrylate		



## Backlight FlexiBowl® 350



Item	CE000342	CE000275	CE000341
Led Colour	Red	Infrared	White
Wavelength	630nm	850nm	N/A
Voltage	24VDC	24VDC	24VDC
Current	0.18A	0,13A	0,18A
Lighting area	220x100mm <sup>2</sup>		
Housing material	Aluminium alloy		
Working Temperature	-40--85°C		
Cable length	0.2m		
Cooling method	Natural air		
Opaline Material	Opaline white methacrylate		



Learn More

## Backlight FlexiBowl® 500

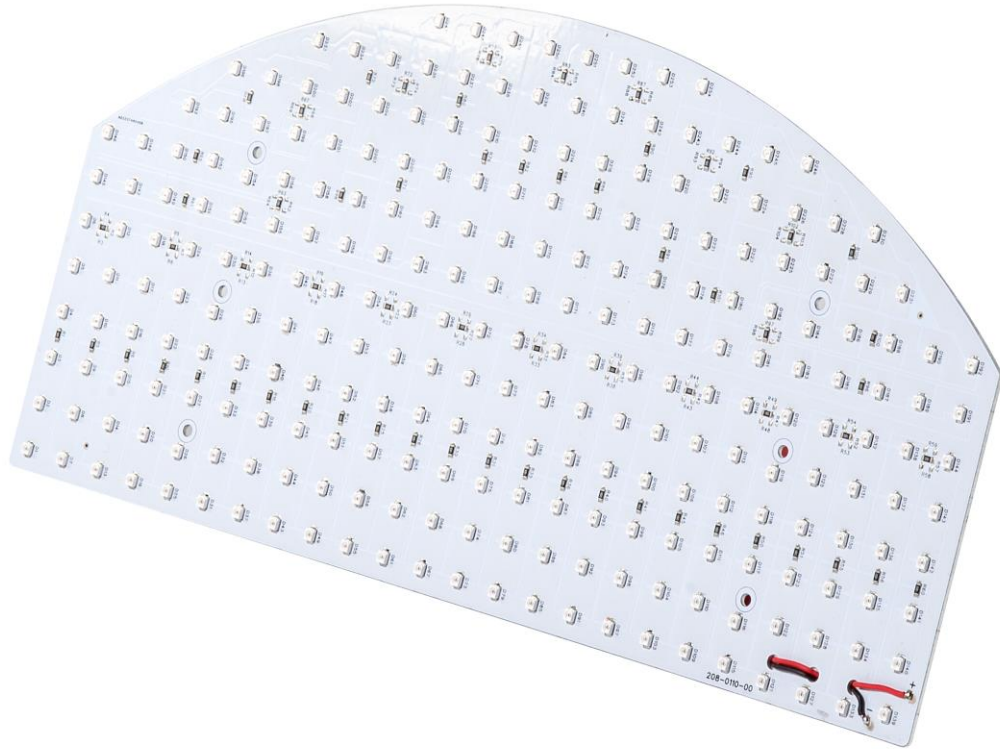

Item	CE000344	CE000272	CE000343
Led Colour	Red	Infrared	White
Wavelength	630nm	850nm	N/A
Voltage	24VDC	24VDC	24VDC
Current	0,46A	0.31A	0,46A
Lighting area	330x170mm <sup>2</sup>		
Housing material	Aluminium alloy		
Working Temperature	-40--85°C		
Cable length	0.2m		
Cooling method	Natural air		
Opaline Material	Opaline white methacrylate		

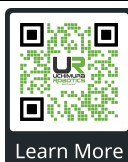

## Backlight FlexiBowl® 650

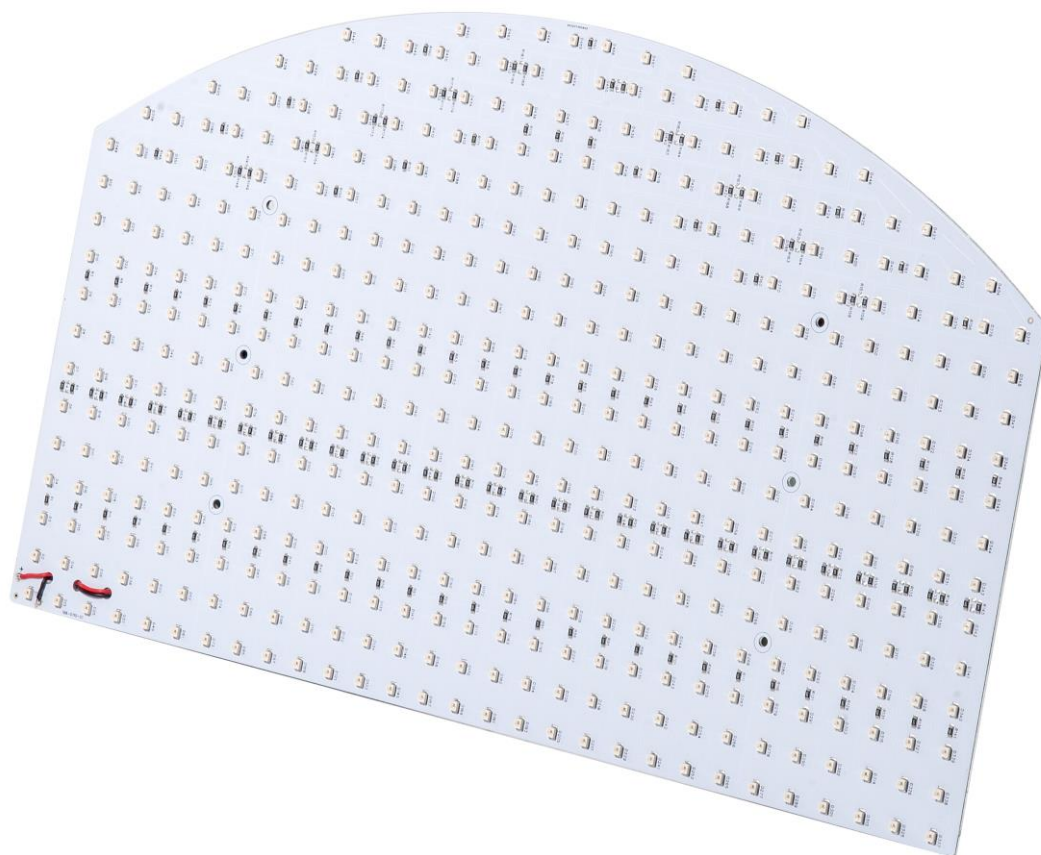

Item	CE000306	CE000273	CE000305
Led Colour	Red	Infrared	White
Wavelength	630nm	850nm	N/A
Voltage	24VDC	24VDC	24VDC
Current	0.86A	0.56A	0.94A
Lighting area	400x240mm <sup>2</sup>		
Housing material	Aluminium alloy		
Working Temperature	-40--85°C		
Cable length	0.2m		
Cooling method	Natural air		
Opaline Material	Opaline white methacrylate		



## Backlight FlexiBowl® 800

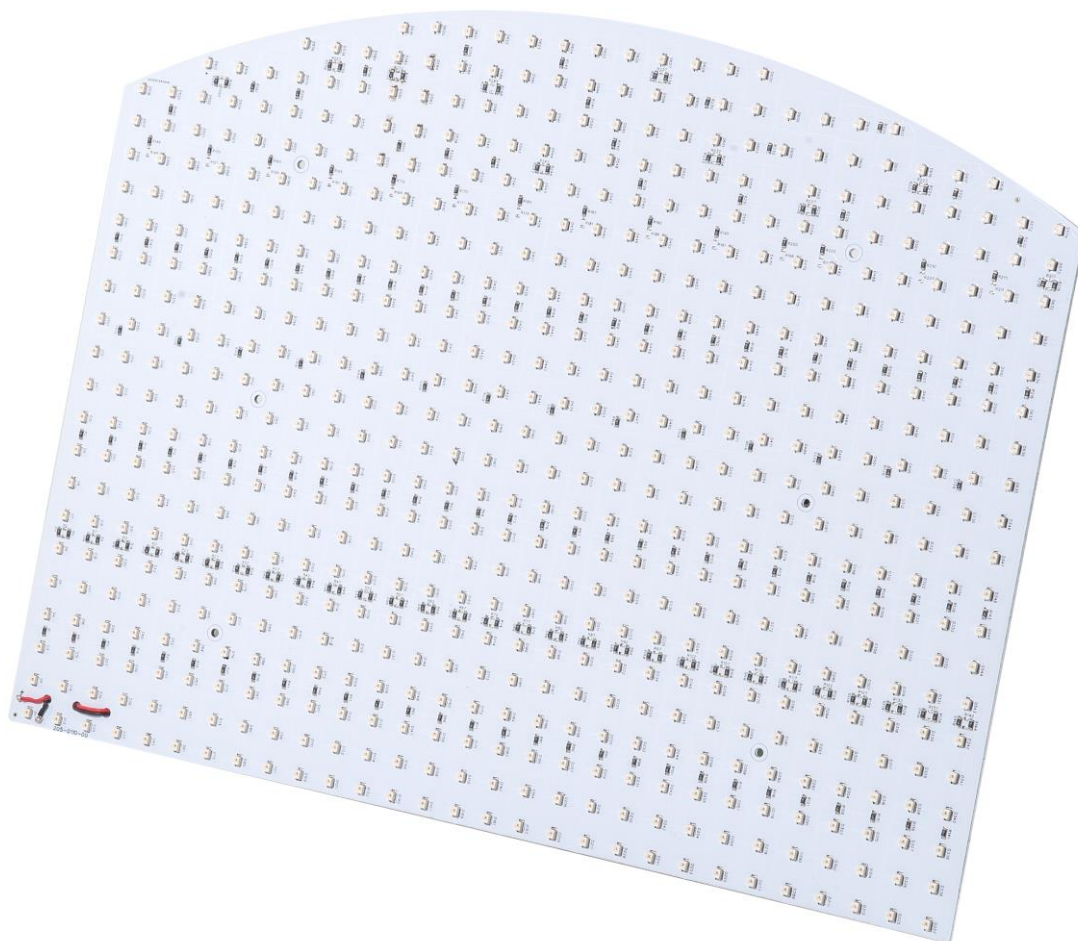

Item	CE000345	CE000274	CE000346
Led Colour	Red	Infrared	White
Wavelength	630nm	850nm	N/A
Voltage	24VDC	24VDC	24VDC
Current	1,15A	0,76A	1,2A
Lighting area	400x315mm <sup>2</sup>		
Housing material	Aluminum alloy		
Working Temperature	-40--85°C		
Cable length	0.2m		
Cooling method	Natural air		
Opaline Material	Opaline white methacrylate		



## Toplight (DOME FlexiBowl® 200/350/500)



Item	GM000591	GM000592	GM000590
<b>Led Colour</b>	Red	Infrared	White
<b>Wavelength</b>	630nm	850nm	N/A
<b>Voltage</b>	24VDC	24VDC	24VDC
<b>Current</b>	1.8A	2.2A	2.2A
<b>Lighting area</b>	480x280mm <sup>2</sup>		
<b>Housing material</b>	Aluminium alloy		
<b>Working Temperature</b>	-40--85°C		
<b>Cable length</b>	5m		
<b>Cooling method</b>	Natural air		
<b>Opaline Material</b>	Opaline white methacrylate		

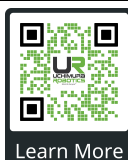

Learn More

## Toplight (DOME FlexiBowl® 650/800)

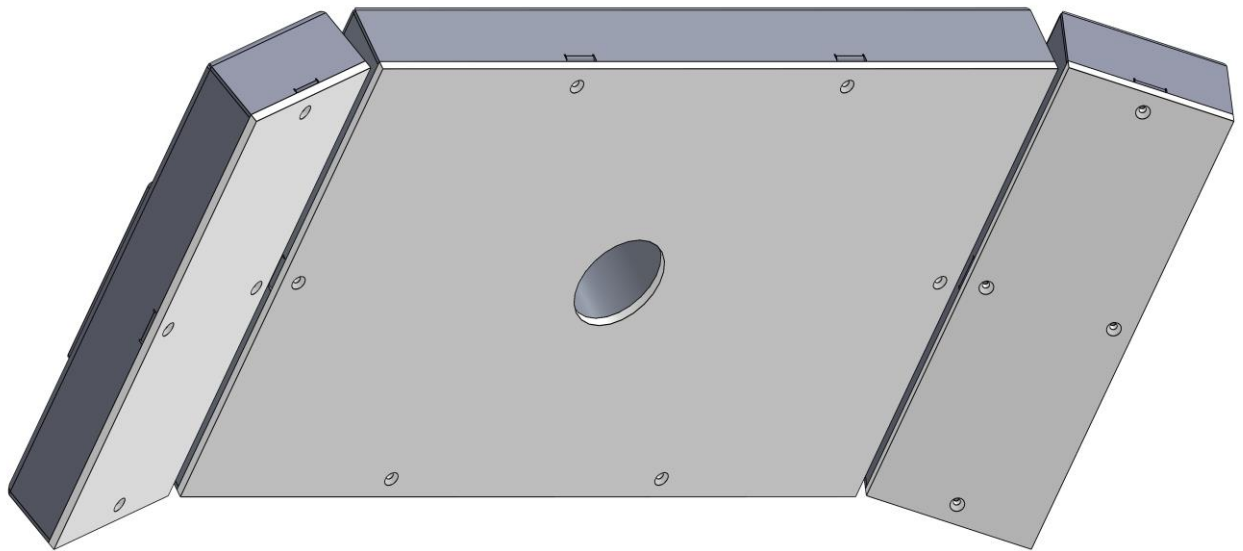

Item	GM000588	GM000587	GM000589
<b>Led Colour</b>	Red	Infrared	White
<b>Wavelength</b>	630nm	850nm	N/A
<b>Voltage</b>	24VDC	24VDC	24VDC
<b>Current</b>	2,5A	2,7A	2,8A
<b>Lighting area</b>	700x280mm <sup>2</sup>		
<b>Housing material</b>	Aluminium alloy		
<b>Working Temperature</b>	-40--85°C		
<b>Cable length</b>	5m		
<b>Cooling method</b>	Natural air		
<b>Opaline Material</b>	Opaline white methacrylate		





## Ring Light

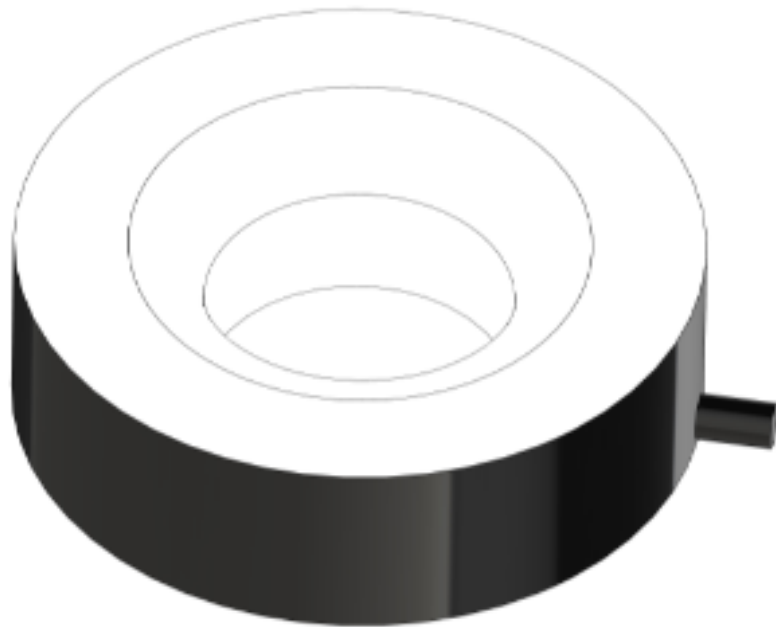

<b>Item</b>	<b>CE000379</b>
<b>Led Colour</b>	White
<b>Voltage</b>	24VDC
<b>Power consumption</b>	16 W max.
<b>Housing material</b>	Aluminium alloy, Resin
<b>Working Temperature</b>	0 to 40°C
<b>Cable length</b>	0.3m
<b>Cooling method</b>	Natural air

