

HitBot Collaborative Robotic Arm

# Product Manual



Huiling-tech Robotic Co., Ltd

## Industrial Robot



## Collaborative Robotic Arm

Leading light collaborative robotic arm provider.

### Human-robot collaboration

Automated upgrade system

Safe

Low cost

Easy to Operate

### Small Batch, Multi-Category Production

Flexible reorganization and easy to adjust workspace

### Drive-Control Integrated System

Extremely saving workspace

### Drag-to-Teach

Get started in 5 minutes without any experience with robot arms. It's simple to operate with open APIs.

Can perform a wide array of dedicated tasks with a free range of motion.

### /High precision/

0.03mm  
Positional Accuracy

### /High speed/

1255.45mm/s

### /Heavy payload/

3kg

### /Large arm span/

J1 axis 200mm  
J2 axis 200mm

### /Wide range of motion/

J1 axis  $\pm 90^\circ$   
J2 axis  $\pm 164^\circ$   
Z axis stroke 210mm  
Unlimited rotation range of R axis

### /Ultrahigh performance -to-cost ratio/

Industrial quality  
consumer affordable

### /Collaboration/

Multi-robot mode  
Human-robot collaboration

### /Communication mode/

Wi-fi  
Ethernet

## Application scenarios

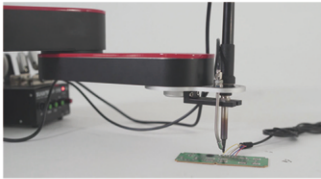

Circuit board welding

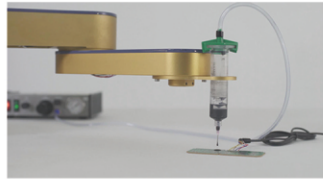

Dispensing

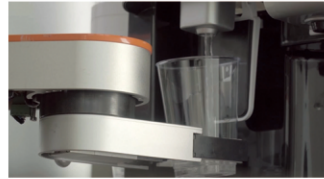

Pick and place

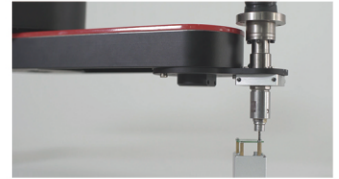

Screw driving

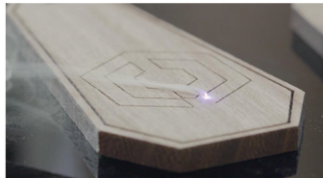

Laser engraving

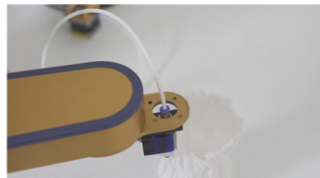

3D Printing



Goods sorting

We can do more, just imagine...

The tool end of Z-Arm can be changed. This meets the requirements of many different applications and tasks. It can be your flexible and efficient assistant and collaborate with you on many projects: 3D printing, pick and place, soldering, laser engraving, object recognition, and so on. The only limit is your imagination.

The SCARA class of robot is highly accurate, fast; has an excellent range of motion for its mid-range price, and is the best selling robot in the medical and 3C industries. The medical field has an extremely strict requirement for the working environment, precision, collaboration and flexibility. A typical industrial robotic arm cannot satisfy these requirements. 3C products are becoming thinner and more integrated, and human production cannot satisfy the progress of these market verticals. However, the Snake released by Hitbot breaks free from this limitation, adopting a z-axis in its design creating the potential of working in a small cell. The cost of this new class of robotic arm dramatically reduces the cost while improving production efficiency.

Additionally, Hitbot's Z-Arm have high accuracy, are equipped with a collaboration capability, and a powerful electric gripper meeting a need in the medical, 3C, small to medium manufacturing and assembly industries.

## Usage

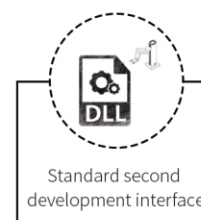
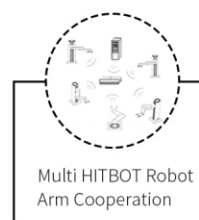
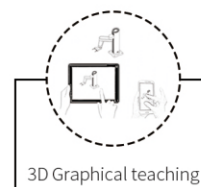
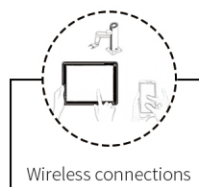

## Specification table

Parameter			Model	
			Z-Arm 2140 non-collaborative	Z-Arm 2140C collaborative
Basic Information	J1-axis	Arm length	200mm	200mm
		Rotation angle	±90°	±90°
	J2-axis	Arm length	200mm	200mm
		Rotation angle	±164°	±164°
	Z-axis	Stroke	210mm	210mm
	R-axis	Rotation angle	±180°	±180°
linear velocity			1255.45mm/s (1.5kg payload)	1023.79mm/s (2kg payload)
Repeatability			±0.03mm	±0.03mm
Rated payload			1.5kg	2kg
Maximum payload			2.5kg	3kg
Degree of freedom			4	4
Power			220V/110V 50~60Hz Adapter to 24V DC	220V/110V 50~60Hz Adapter to 24V DC
Communication			Wifi/Ethernet	Wifi/Ethernet
Extensibility			The built-in motion controller, provides 10 I/O	The built-in motion controller, provides 10 I/O
I/O □	Digital input (isolated)		5	5
	Digital output (isolated)		5	5
	Analog input(4-20mA)		/	/
	Analog output (4-20mA)		/	/
Height			565mm	565mm
Weight			19kg	19kg
Base installation parameters	Overall size		250mm*250mm*10mm	250mm*250mm*10mm
	Mounting hole spacing		200mm*200mm with 4 M8*25 screws	200mm*200mm with 4 M8*25 screws
Collision detection			×	√
Handhold teaching			×	√

## Range of motion and dimensional drawing

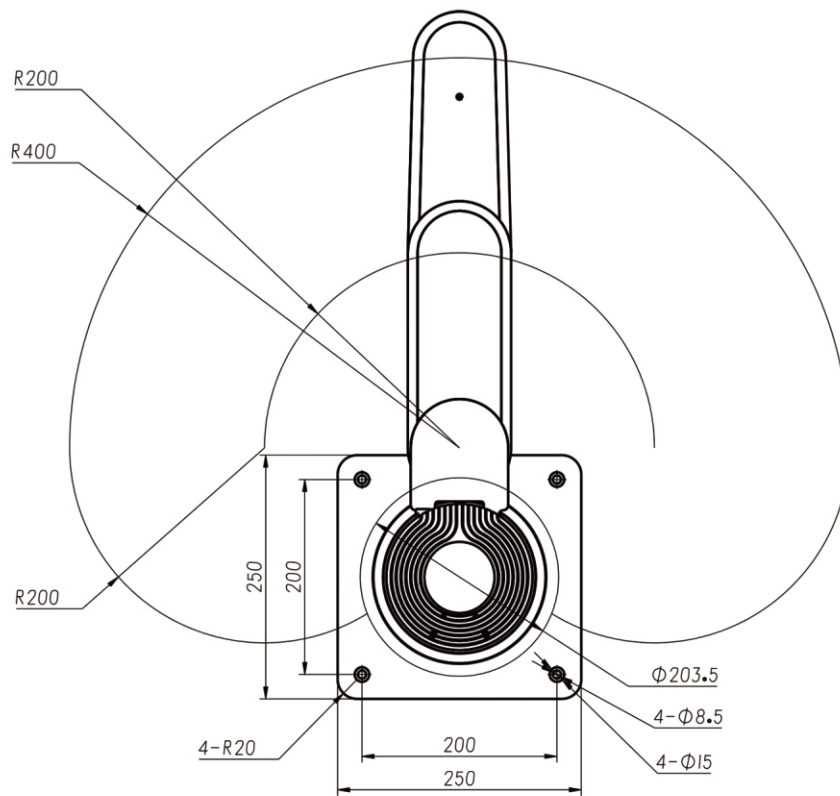
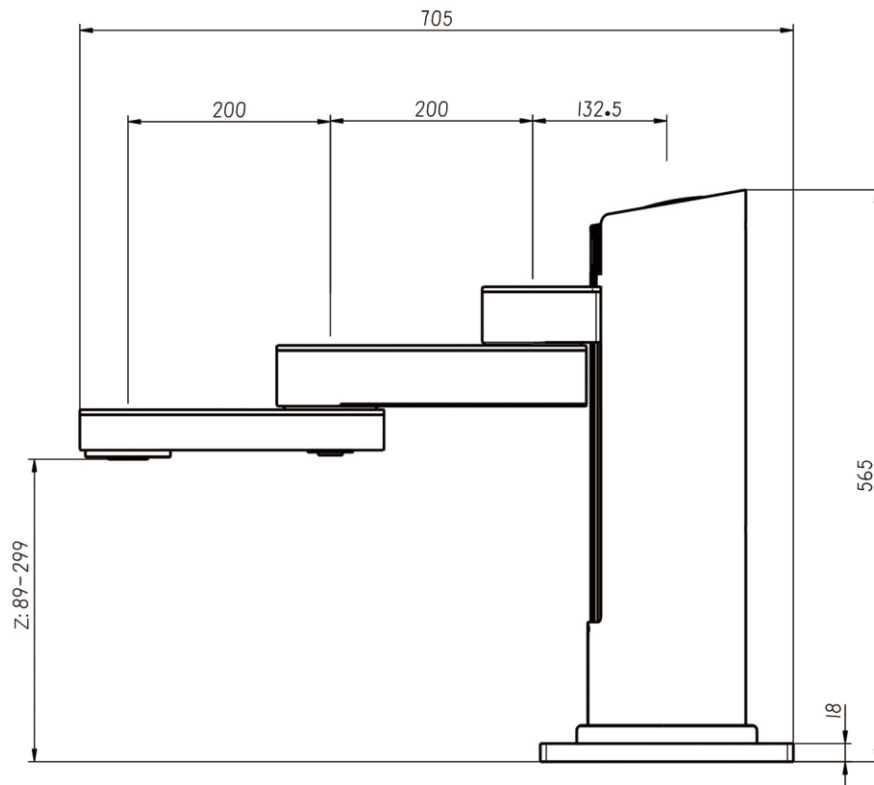



## Huiling-tech Robotic Co., Ltd

Tel 0755-36382405

Email [hitbot@hitbot.cc](mailto:hitbot@hitbot.cc)

Website [www.hitbot.cc](http://www.hitbot.cc)

Address #503-505, G Building, Baoan Zhigu science and Technology Park,  
Yintian Road 4, Xixiang, Shenzhen, Guangdong, PR China

